



Item #65500

CONTOUR DSB DUSTLESS SANDING BLOCK SYSTEM

SET-UP AND OPERATING INSTRUCTIONS



The **EASTWOOD ELITE CONTOUR DUSTLESS SANDING BLOCK (DSB) SYSTEM** contains a revolutionary sanding block that not only collects over 95% of filler sanding dust, but also ensures a truly flat surface, maximizes sandpaper life, and contours to automotive body panels. This system can also be used for home improvement when sanding drywall with great effect.

The Dustless Sanding Block (DSB) features patent pending technology developed and tested in-house by Eastwood to virtually eliminate the age-old problem of sanding dust making a mess in your shop or home. The DSB was modeled using computer fluid dynamic studies to verify the vacuum assist provides equal suction at every point on the sanding face. In addition, innovative material selection and design give the DSB the ideal amount of flex to contour to your body panels. Evacuation of the sanding dust reduces loading of the sandpaper, allowing for longer sandpaper life.

Included adapters allow the system to work with standard shop vacuum 1.25" and 1.75" vacuum hoses. The 15' of vacuum hose included is crush-proof, and resists kinking without impeding sanding movement.

The Eastwood Elite DSB System works together with your shop vacuum. Peak performance can only be attained when used in conjunction with a properly operating / maintained vacuum.

STATEMENT OF LIMITED WARRANTY

The Eastwood Company (hereinafter "Eastwood") warrants to the end user (purchaser) of all new Eastwood-branded tools and chemicals (collectively called the "products") that each will be free of defects in workmanship and material. This warranty is void if the equipment has been subjected to improper installation, improper care or abnormal operations.

WARRANTY PERIOD:

All warranty periods begin on the date of purchase from Eastwood. Warranty Periods are listed below, along with the products covered during those warranty periods:

3-Year Warranty on Material, Workmanship, and Defects:

- | | | | |
|--------------------------------------|--------------------------------|--|---------------------------------|
| • Eastwood MIG 135 Welder | • Eastwood TIG 200 DC | • Eastwood MIG 175 Welder | • Eastwood TIG 200 AC/DC |
| • Eastwood MIG 250 Welder | • Eastwood MP140i Welder | • Eastwood TIG 200 Digital | • Eastwood MP200i Welder |
| • Eastwood Versa-Cut 20 | • Eastwood Elite MP250i Welder | • Eastwood Versa-Cut 40 | • Eastwood 90A Flux Core Welder |
| • Eastwood Versa-Cut 60 | • Eastwood ARC 80 Stick Welder | • Eastwood Rotisserie | • Eastwood Contour SCT® |
| • Eastwood Elite AC/DC MP200i Welder | • Concoours Pro HVLP Paint Gun | • Eastwood Elite Contour DSB – Dustless Sanding Block System | |

Items not covered under this warranty: Consumables, unless deemed defective, are not covered by the 3-year warranty. Abuse, neglect, and lack of maintenance is not covered under this warranty. All other components are covered by the warranty and will be repaired or replaced at the discretion of Eastwood.

2-Year Warranty on Material, Workmanship and Defects:

- | | | | |
|--|--------------------------------------|--------------------------------------|--------------------------------------|
| • Eastwood Air QST-30/60 Scroll Compressor | • Eastwood 80 Gal. 7.5 HP Compressor | • Eastwood 80 Gal. 5 HP Compressor | • Eastwood 60 Gal. 4.7 HP Compressor |
| • Eastwood 60 Gal. 3.7 HP Compressor | • Eastwood Panoramic Welding Helmet | • Eastwood 30 Gal. 1.9 HP Compressor | • Eastwood XL View Welding Helmet |
| • Eastwood Lg View Welding Helmet | • Eastwood Auto Darkening Helmet | • Concoours 2 HVLP Paint Gun | |

Items not covered under this warranty: Consumables, unless deemed defective, are not covered by the 2-year warranty. Abuse, neglect, and lack of maintenance is not covered under this warranty.

1-Year Warranty on Material, Workmanship and Defects:

- | | |
|-------------------------------------|-------------------|
| • Eastwood Tools Not Included Above | • Fairmount Tools |
|-------------------------------------|-------------------|

Items not covered under this warranty: Consumables, unless deemed defective, are not covered by the 1-year warranty. Abuse, neglect, and lack of maintenance is not covered under this warranty.

90-Day Warranty on Material, Workmanship and Defects:

- | | |
|-------------------------------|------------------|
| • Eastwood Paints & Chemicals | • Rockwood Tools |
|-------------------------------|------------------|

Items not covered under this warranty: Consumables, unless deemed defective, are not covered by the 90-day warranty. Abuse, neglect, and lack of maintenance is not covered under this warranty.

Lifetime Warranty on Material, Workmanship and Defects:

- Selected Eastwood Hand Tools carry a Limited Lifetime Warranty

Items not covered under this warranty: Abuse, neglect, and lack of maintenance is not covered under this warranty.

CONDITIONS TO OBTAIN WARRANTY COVERAGE:

- Proof of purchase must be provided for all warranty claims
- Purchaser must first contact Eastwood at 1-800-343-9353 for an RMA Number before Eastwood will accept any warranty returns. Final determination of warranty on welding and cutting equipment will be made by Eastwood.

WARRANTY REPAIR: If Eastwood confirms the existence of a defect covered under this warranty plan, Eastwood will determine whether repair or replacement is the most suitable option to rectify the defect. At Eastwood's request, the purchaser must return, to Eastwood, any products claimed defective under Eastwood's warranty.

FREIGHT COSTS: The purchaser is responsible for shipment to and from Eastwood.

WARRANTY LIMITATIONS:

EASTWOOD WILL NOT ACCEPT RESPONSIBILITY OR LIABILITY FOR REPAIRS UNLESS MADE BY EASTWOOD. EASTWOOD'S LIABILITY UNDER THIS WARRANTY SHALL NOT EXCEED THE COST OF CORRECTING THE DEFECT OF THE EASTWOOD PRODUCT. EASTWOOD WILL NOT BE LIABLE FOR INCIDENTAL OR CONSEQUENTIAL DAMAGES (SUCH AS LOSS OF BUSINESS, ETC.) CAUSED BY THE DEFECT OR THE TIME INVOLVED TO CORRECT THE DEFECT. THIS WRITTEN WARRANTY IS THE ONLY EXPRESS WARRANTY PROVIDED BY EASTWOOD WITH RESPECT TO ITS PRODUCTS. WARRANTIES IMPLIED BY LAW SUCH AS THE WARRANTY OF MERCHANTABILITY ARE LIMITED TO THE DURATION OF THIS LIMITED WARRANTY FOR THE EQUIPMENT INVOLVED. THIS WARRANTY GIVES THE PURCHASER SPECIFIC LEGAL RIGHTS. THE PURCHASER MAY ALSO HAVE OTHER RIGHTS WHICH VARY FROM STATE TO STATE.

CONTENTS

- (1) 11" Dustless Sanding Block Assembly [A]
- (1) 15' Vacuum Hose with Flow Control Valve and Primary Adapter Regulator installed [B]
- (1) 1.75" Vacuum Hose Adapter [C]



SPECIFICATIONS

Shop Vacuum requirements: 3.0 PHP (Peak Horse Power) is the minimum recommend for optimal performance. The vacuum should have a HEPA filter or HEPA bag installed to reduce respiratory health damage risk.

Sandpaper compatibility: Eastwood Elite Contour DSB PSA Paper.

- #65490 80 Grit
- #65489 120 Grit
- #65488 180 Grit
- #65487 220 Grit
- #65486 320 Grit
- #65485 420 Grit

SAFETY INFORMATION

READ AND UNDERSTAND ALL INSTRUCTIONS AND PRECAUTIONS BEFORE PROCEEDING.

Failure to follow all instructions listed below may result in personal injury. Save all warnings and instructions for future reference.

⚠ DANGER

DANGER indicates a hazardous situation which, if not avoided, will result in death or serious injury.

⚠ WARNING

WARNING indicates a hazardous situation which, if not avoided, could result in death or serious injury.

⚠ CAUTION

CAUTION indicates a hazardous situation which, if not avoided, could result in minor or moderate injury.

⚠ NOTICE

NOTICE is used to address practices not related to personal injury.



⚠ WARNING HEALTH AND INJURY HAZARDS!

- Dust and fine particulate matter is generated during the sanding process which can contain toxic substances such as lead, silica, solvents and others. Breathing this dust and fine particulate matter can cause many serious respiratory health conditions. Always use NIOSH approved respiratory protection while using this tool.
- Moving abrasive surfaces can eject metal particles, dirt and debris at high velocity. Always wear ANSI approved eye protection when operating this tool.
- Utilizing a shop vacuum can generate excessive noise. Wear appropriate hearing protection while using a shop vacuum.
- Sanding can result in abrasion to the hands and involves working around sharp edges. Always wear protective work gloves when sanding.

⚠ CAUTION INJURY HAZARD!

- Sanding may result in your hands becoming pinched, particularly in tight areas. Take care when sanding in tight areas and always wear protective work gloves.
- Moving around hoses and sanding in unusual positions makes tripping easy. Exercise caution when moving around the work area and always make sure you are sure-footed.
- Repetitive motions involved in sanding can cause Repetitive Strain Injury (RSI). Take frequent breaks to avoid strain injuries.
- The shop vacuum can eject dust and fine particulate matter during operation. Breathing this dust and fine particulate matter can cause many serious respiratory health conditions. The vacuum should always have a HEPA filter or HEPA bag installed to minimize this risk during operation.



⚠ NOTICE

- Do not sand on surfaces hotter than 120°F. Damage to the Dustless Sanding Block may occur.
- Turn off the shop vacuum when changing sandpaper. Alignment of sandpaper while the vacuum is operating may be difficult.

⚠ NOTICE

- Proper adjustment of the Flow Control Valve (e) and the Primary Adapter Regulator Ring (g) are essential for optimal performance of the DSB System and to prevent the vacuum from stalling and possible overload. See Airflow Adjustment Guideline Table for set-up tips.

COMPONENT IDENTIFICATION

- [a] Dustless Sanding Block
- [b] Vacuum Plate
- [c] Hose Fitting
- [d] Vacuum Hose Assembly
- [e] Flow Control Valve
- [f] Primary Adapter Regulator
- [g] Primary Adapter Regulator Ring
- [h] 1.75" Vacuum Hose Adapter

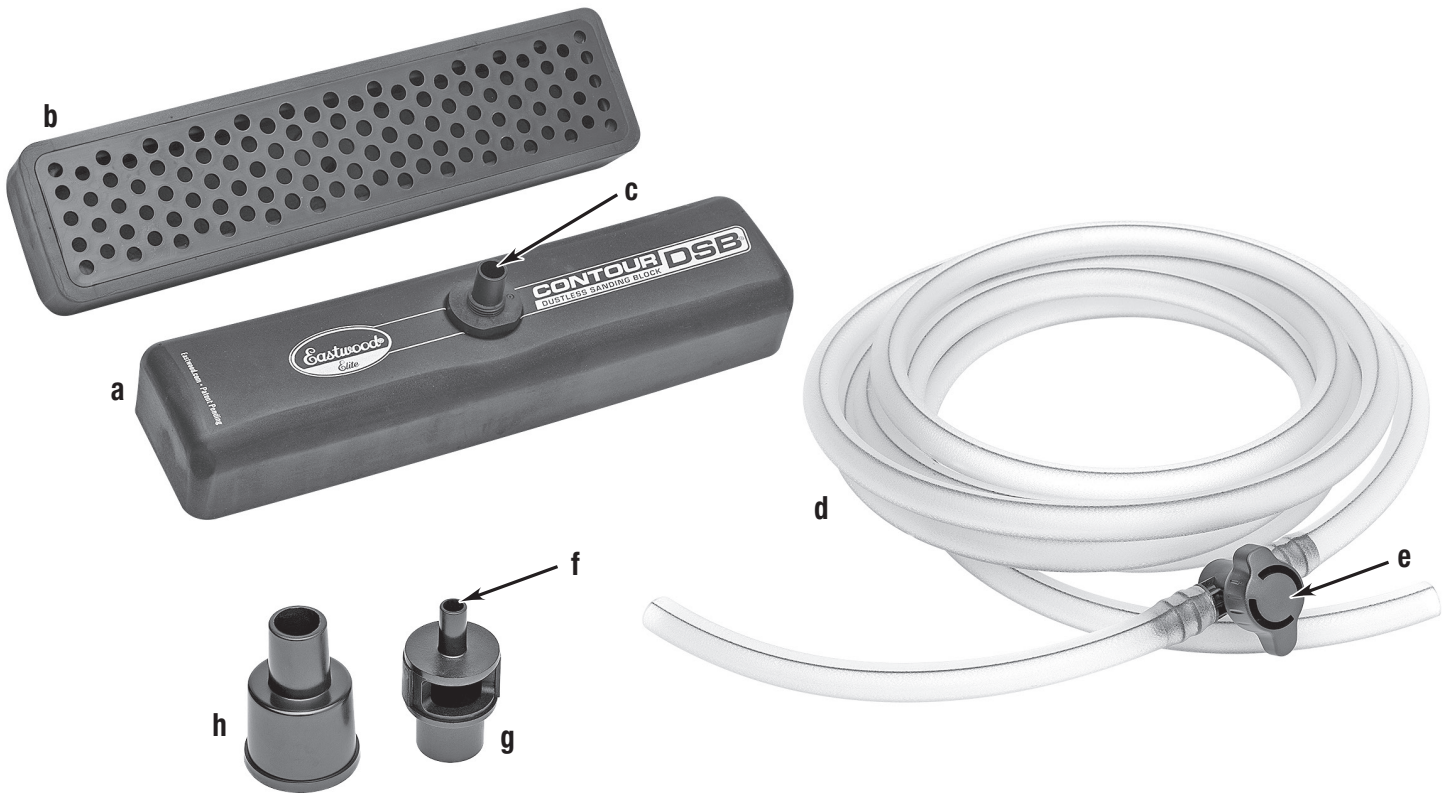

DSB SYSTEM SET-UP

VACUUM HOSE SET-UP

- Install the end of the longer hose section of the Vacuum Hose Assembly [d] to the Hose Fitting [c] on the Dustless Sanding Block (FIG 1).
- Verify the Primary Adapter Regulator [f] is installed to the shorter hose section of the Vacuum Hose Assembly [d] (FIG 2).

NOTE: The Primary Adaptor Regulator (f) **MUST** be used with the DSB System to prevent the vacuum from stalling or overheating.

CONNECTING TO A SHOP VACUUM

- If utilizing a shop vacuum with a 1.25" vacuum hose end: Connect it directly to the Primary Adapter Regulator [f] as shown in (FIG 3).
- If utilizing a shop vacuum with a 1.75" vacuum hose end: Use the included 1.75" Vacuum Hose Adapter [h] in conjunction with the Primary Adapter Regulator [f] to connect to the to the hose end (FIG 4).

TECH TIP: *Wrapping electrical tape around the adapters works great to tighten up the fitment if loose.*

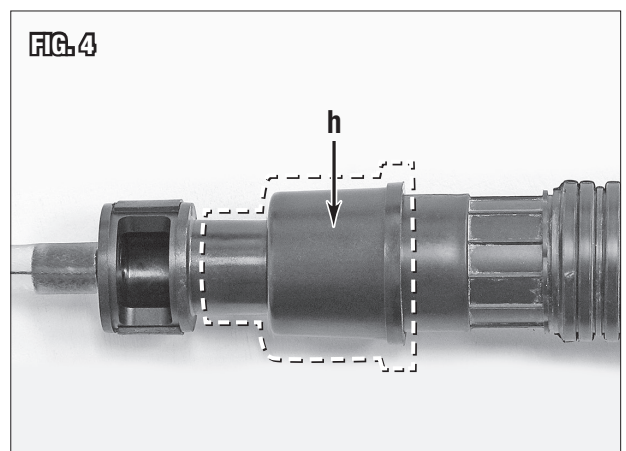
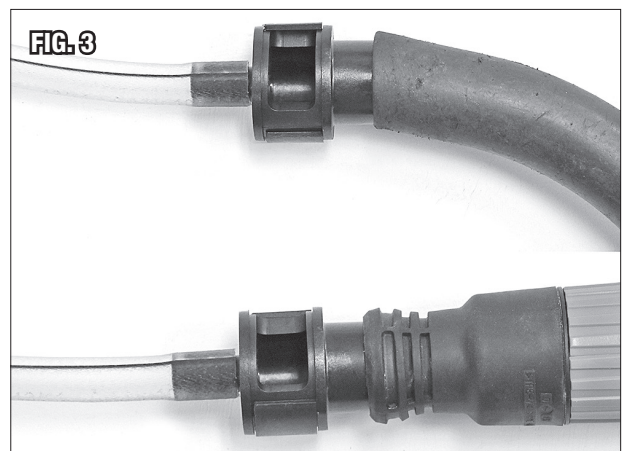
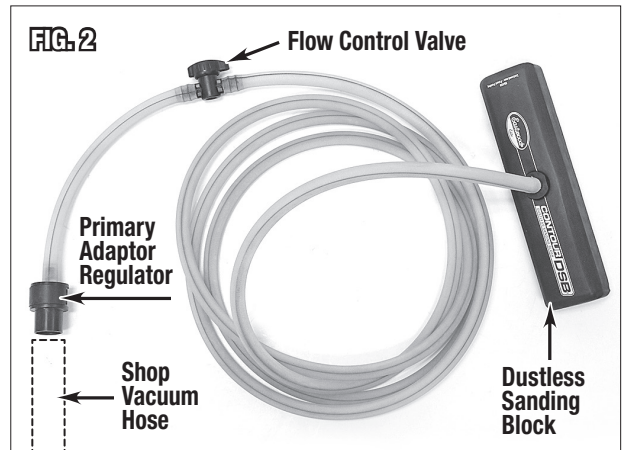
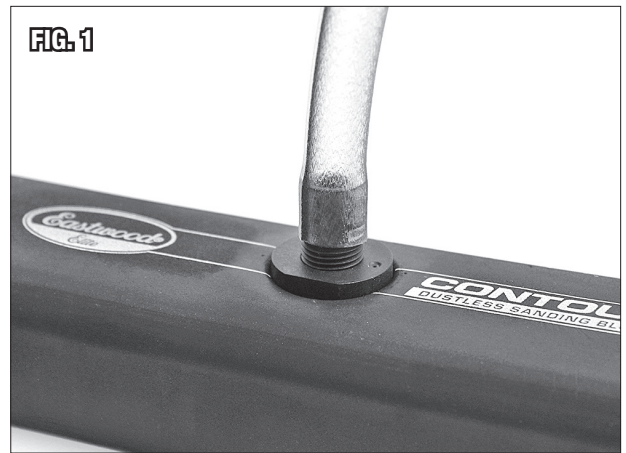

ADHERING PSA SANDPAPER TO THE DSB



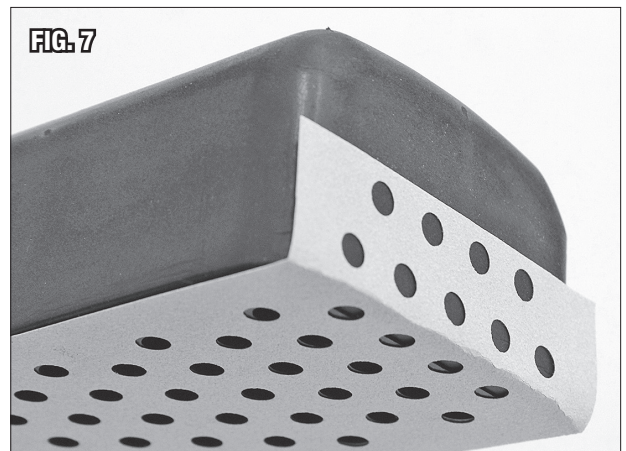
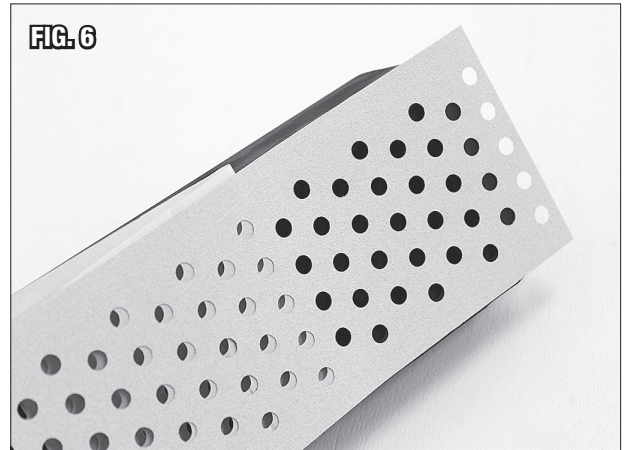
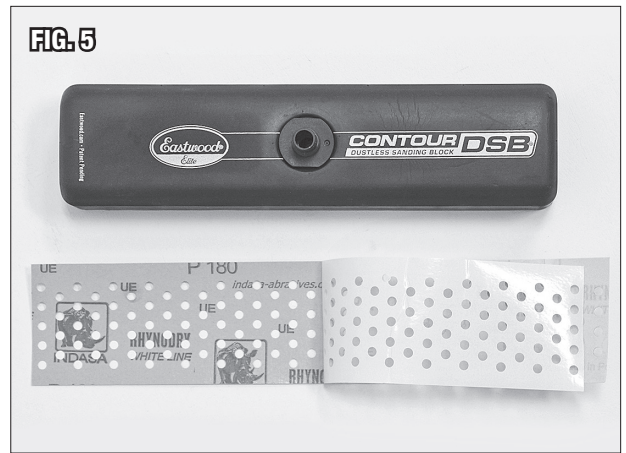

- Tear off a section of sandpaper from the roll that is 1 - 2" longer than the DSB.
- Peel back the protective film approximately halfway down the section (**FIG 5**).
- Align the paper to the DSB with 1/2" - 1" of overhang and make sure the hole pattern in the sandpaper aligns with the hole pattern in the Vacuum Plate **[b]** of the DSB (**FIG 6**).
- With alignment verified, remove the remainder of the protective film and firmly press the sandpaper onto the Vacuum Plate **[b]**. Fold up the edges of the sandpaper and stick them to the sides of the block (**FIG 7**).

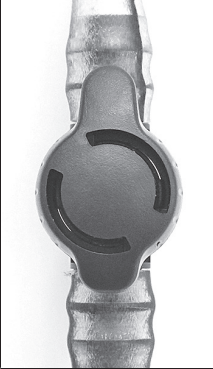
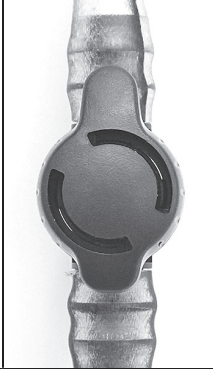
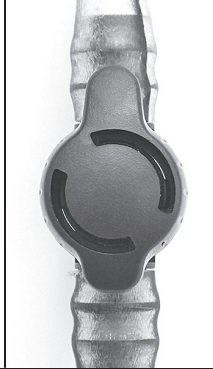
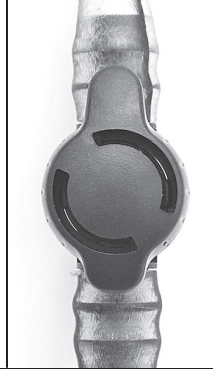

ADJUSTING AIRFLOW

- The components controlling airflow to the DSB are the Flow Control Valve [e] and the Primary Adapter Regulator Ring [g] on the Primary Adapter Regulator [f].
- Reference the **AIRFLOW ADJUSTMENT GUIDELINE TABLE** below for an adjustment to start with based on what grit sandpaper you are using. This is only a starting point and further fine tuning may be necessary. Reference the following steps for fine tuning.

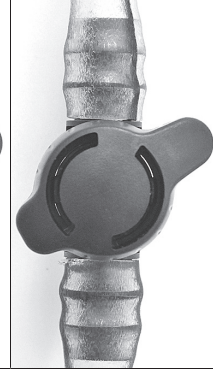
AIRFLOW ADJUSTMENT GUIDELINE TABLE

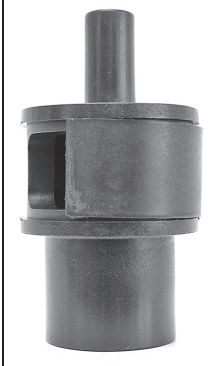
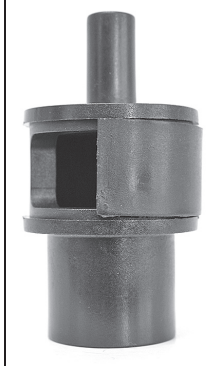
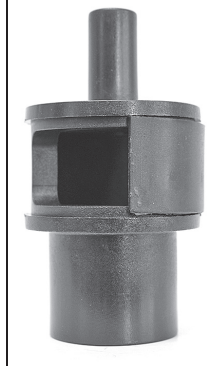
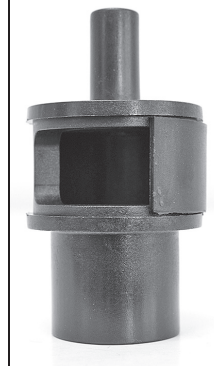
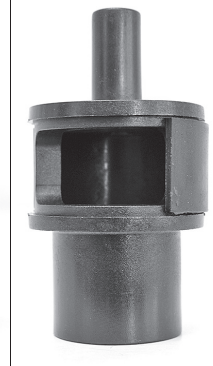
Component	Sandpaper Grit					
	80 Grit	120 Grit	180 Grit	220 Grit	320 Grit	420 Grit
Flow Control Valve (e)						
Primary Adapter Regulator Ring (g)						

- If the DSB feels like it is sticking or is hard to move on smooth surfaces, gradually close the Flow Control Valve [e] by turning it clockwise until sanding motion is smooth.
- If the DSB is not capturing sanding dust, further close the Primary Regulator Adapter Ring [g] until dust is being collected. If this has no effect, verify the vacuum filter or bag is not clogged or overfilled.

DSB SYSTEM OPERATION

AUTOMOTIVE BODY FILLER APPLICATION TIPS

- Always spread thin layers of body filler on the panel. Never apply a layer greater than 1/16" thick.
- If the low spot requires more than 1/16" of filler, add filler in layers to build it up.
- Begin sanding the body filler after it has cured. One rule of thumb is if you cannot indent the filler with your fingernail, it is ready to sand.

HOW TO BLOCK SAND BODY FILLER

For the best results and to help produce as level of a surface as possible, it is very important to sand in alternating directions, using a crisscrossing, "Cross-Block" technique in the sanding pattern by working the sanding strokes at 45° angle to previous sanding passes. Sanding constantly in a straight line, in the same direction should be avoided.

- Always utilize a powder or liquid guide coat such as **#12416Z Eastwood Guide Coat Black Aerosol 12 oz.** to ensure correct leveling and removal of sanding scratches. Apply an even, light coat covering the sanding area (**FIG 8**).
- We highly recommend starting the sanding process with 80 grit sandpaper and going sequentially up through the grits (80 grit > 120 grit > 180 grit > 220 grit > 320 grit > 400 grit) during the sanding process. Skipping grits will result in sanding scratches not being fully removed.
- Utilize the largest sanding block that will fit the body panel to make quick work of it.
- The DSB can be used with a variety of hand positions. One-handed operation (**FIG 9**) and two-handed operation (**FIG 10**) are easy. Looping the hose as shown in (**FIG 11**) will relieve strain at the Hose Fitting if it pulls off when sanding.

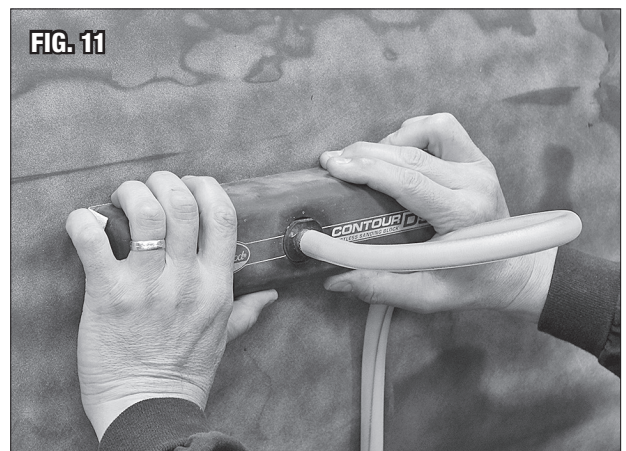
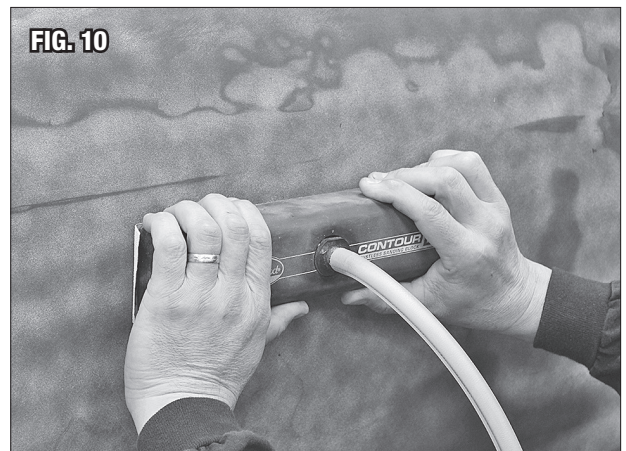
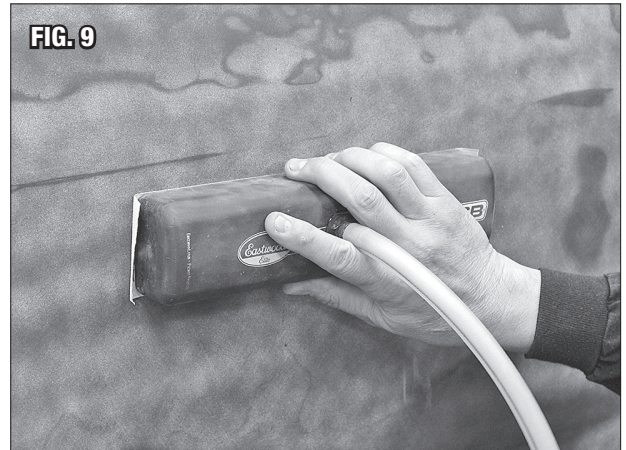
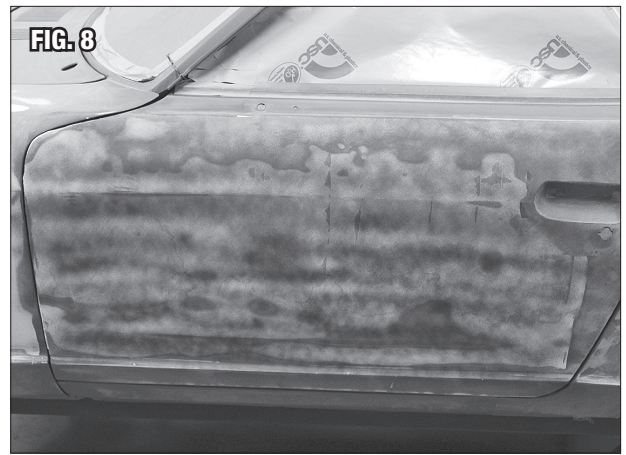

- Start by sanding across the work area 45° in on direction (**FIG 12**). Once across the work area, return back making a cross pattern (**FIG 13**). Repeat until appearance is smooth, making the highs (bare metal showing) and lows (black guide coat showing) of the panel prominent (**FIG 14**).
- Tap down the highs with a body hammer (**FIG 15**).
- For panels with lesser surface area such as windshield pillars, cowl areas etc., hand-sanding can be done with the fingers behind the sandpaper, but they must travel while at a 45° angle to the surface. Never sand with the fingers in-line with an area or it will cause grooving in the primed/filled surface (**FIG 16**).
- When encountering a body character line, styling feature or crease, never sand over it but sand up-to it. The feature can be lightly hand-sanded afterward (**FIG 14**).

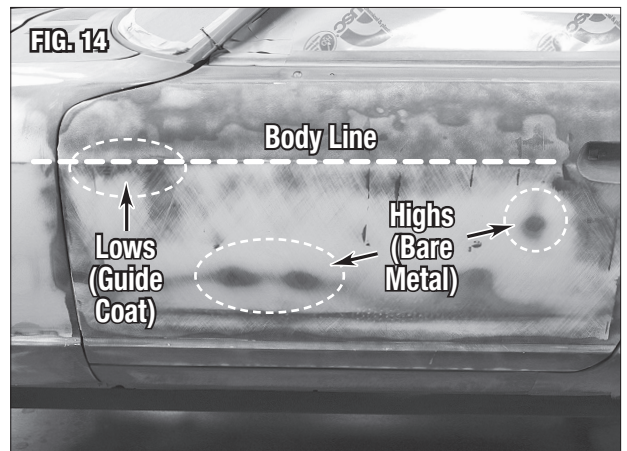
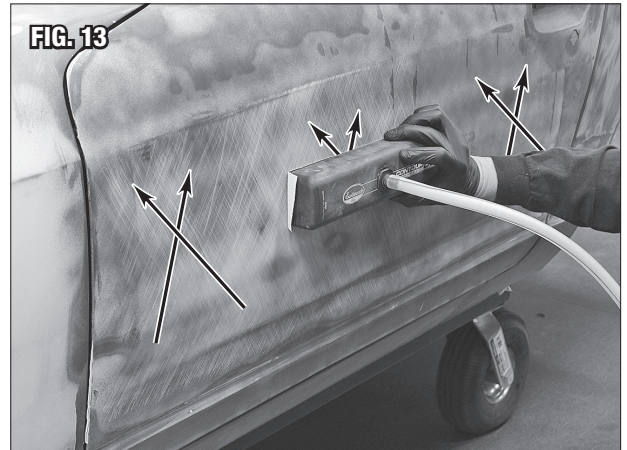
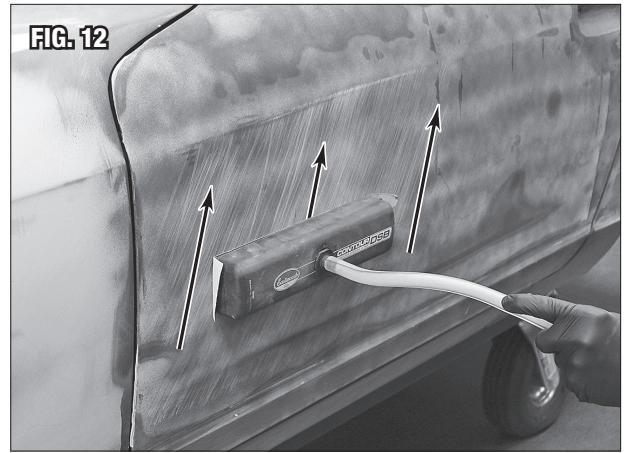

DSB SYSTEM MAINTENANCE

- After a sanding project is finished, the DSB System should be cleared of sanding dust buildup with compressed air before storage.
- Utilizing an air gun, blow out the Primary Adapter Regulator, 15' Hose and Flow Control Valve. Verify there is no sanding dust buildup stuck in these components.
- Blow out the Dustless Sanding Block through the holes in the Vacuum Plate, then through the Hose Fitting.
- If dust buildup persists in any of these components - utilize a cleaning brush to break it free.

▲ NOTICE

Failure to clear sanding dust buildup from the components before storage may result in hardened sanding dust buildup impeding airflow and block performance. Always clear the components before storage.

TROUBLESHOOTING

PROBLEM	CAUSE	CORRECTION
DSB Does Not Pick Up Dust	Poor airflow adjustment	See ADJUSTING AIRFLOW to fine tune the performance of the DSB.
	Vacuum filter clogged	Clean or replace vacuum filter.
	Vacuum bag full	Replace vacuum bag.
	Dust blockage in the vacuum hose	Inspect for blockages. Clear blockages with compressed air.
Sandpaper Does Not Stick to DSB Vacuum Plate	Vacuum plate contaminated with dust	Wipe down the vacuum plate to clear it of dust impeding the adhesion.
DSB is "Sticking" or Hard to Move When Sanding	Poor airflow adjustment	See ADJUSTING AIRFLOW to fine tune the performance of the DSB.
Vacuum Hose Slipping off DSB Hose Fitting During Use	Hose end worn out	With a sharp blade, cut off the vacuum hose end approximately 1" from the end. Make sure the cut is clean and square with the hose for best grip on the Hose Fitting.

DSB VACUUM HOSE EXTENSION

- Optionally, an additional 15' Vacuum Hose (#65496, not included) may be added between the Flow Control Valve and Dustless Sanding Block with a 1/2" outside diameter coupler (not included). Couplers are commonly available from home improvement or automotive centers.
- This will double the length of the vacuum hose and allows you to place your shop vacuum in a more remote location to reduce noise in the work area.

ADDITIONAL ITEMS

R&D MUST-HAVE ACCESSORIES



#12416z
Eastwood Guide Coat



#60002
Eastwood Car Parts Cart



#13520z
Eastwood Contour Premium Body Filler

Visit eastwood.com for complete info and pricing.

CONSUMABLE ITEMS

- #65490** Eastwood Elite Contour DSB 80 Grit PSA Paper
- #65489** Eastwood Elite Contour DSB 120 Grit PSA Paper
- #65488** Eastwood Elite Contour DSB 180 Grit PSA Paper
- #65487** Eastwood Elite Contour DSB 220 Grit PSA Paper
- #65486** Eastwood Elite Contour DSB 320 Grit PSA Paper
- #65485** Eastwood Elite Contour DSB 420 Grit PSA Paper

OPTIONAL ITEMS

- #65497** Eastwood Elite 5" Dustless Sanding Block
- #65499** Eastwood Elite 16" Dustless Sanding Block
- #65496** 15' Vacuum Hose

REPLACEMENT ITEMS

- #65493** Primary Adapter Regulator
- #65494** 1.75" Vacuum Hose Adapter
- #65495** Flow Control Valve
- #65498** Eastwood Elite 11" Dustless Sanding Block

If you have any questions about the use of this product, please contact

The Eastwood Technical Assistance Service Department: 800.343.9353 >> email: tech@eastwood.com

PDF version of this manual is available at eastwood.com

The Eastwood Company 263 Shoemaker Road, Pottstown, PA 19464, USA 800.343.9353 eastwood.com